

YX3 315 S-6 IE2

Abmessungen Drehstrom-Asynchronmotor / dimensions three phase asynchron motor IM B35 (mm)

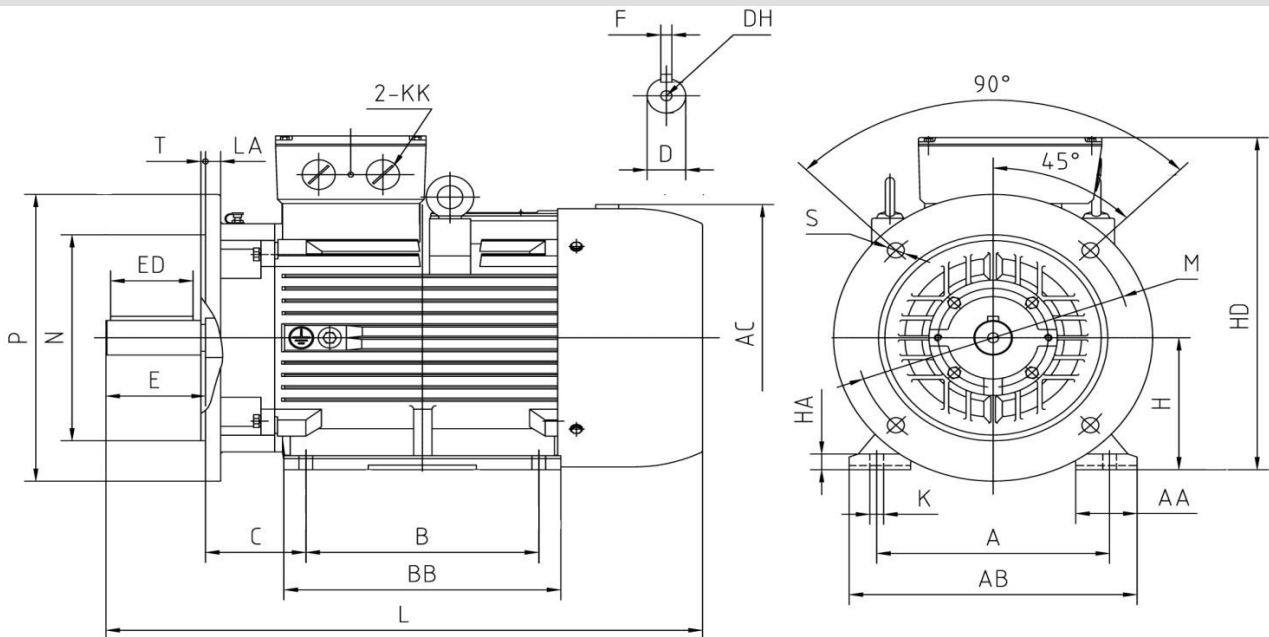

Abmessungen / dimension

A	AA	AB	AC	B	BB	C	E	ED	H	HD	HA	L	K	D	DH	KK
508	120	635	Ø650	406	565	216	170	140	315	870	45	1210	28	Ø80	M20x42	M63x1,5
P	M	N	T	LA	S	F										
Ø660	Ø600	Ø550	6	24	8xØ24	22										

Technische Daten / technical dates

Typ / type	YX3 315 S-6 IE2		Nennmoment / rated torque	(Nm)	722,8
Leistung / power	(kW)	75,0	Anlaufstrom-Nennstrom / starting current-rated current	(I _a /I _n)	6,7
Betriebsart / duty	S1		Anzugsmoment-Nennmoment / starting torque-rated torque	(M _a /M _n)	2,3
Nennzahl/ speed	(min ⁻¹)	990	Kippmoment-Nennmoment / Pull-out torque	(M _k /M _n)	2,9
Nennstrom / rated current 400 V	(A)	134,6	Massenträgheitsmoment / moment of inertia	(kgm ²)	4,3155
Spannung / voltage (50 Hz)	(V)	380-420/660-720(Δ/Y)	Umgeb.-temp./ ambient temperature	40°C	
Frequenz / frequency	(Hz)	50	Lager / bearing	(DE)	6319
Wirkungsgrad / efficiency	(%)	94,2		(NDE)	6319
Leistungsfaktor / power factor	(cos φ)	0,85	Schutzart / protection	IP55	
Isolationsklasse / insulation class	F		Schallpegel / noise level	(dB (A))	76
			Gewicht / weight	(kg)	976

Schaltplan / connection diagram

