

YX3 280 S-4 IE2

Abmessungen Drehstrom-Asynchronmotor / dimensions three phase asynchron motor IM B3 (mm)

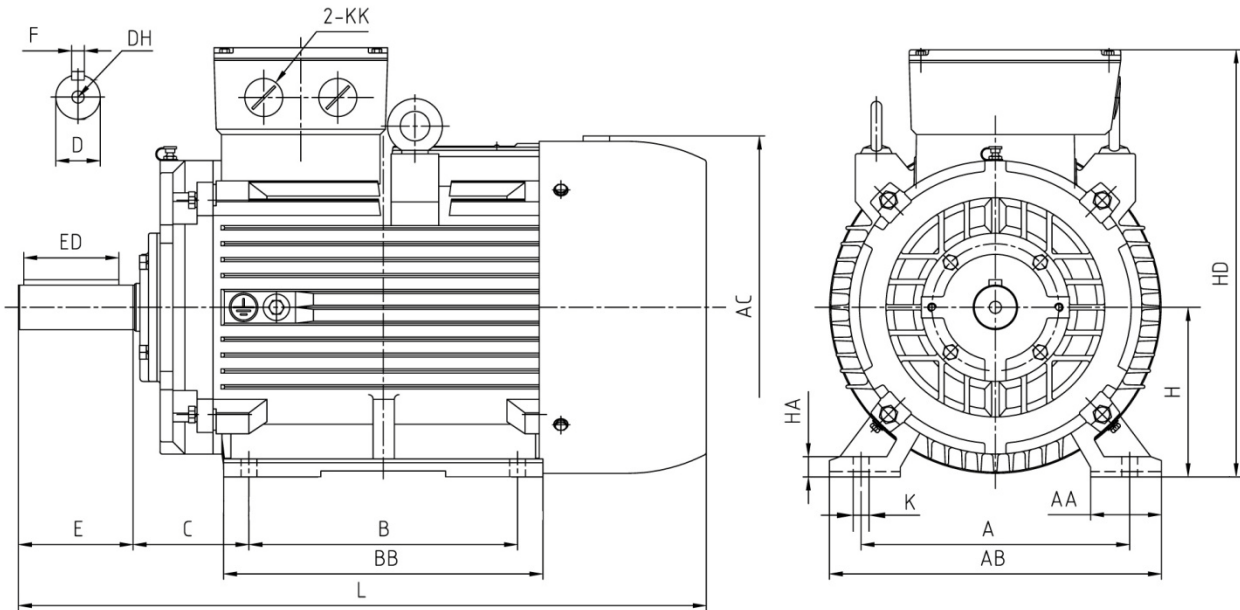

Abmessungen / dimension

A	AA	AB	AC	B	BB	C	E	ED	H	HD	HA	L	K	D	F	DH	KK
457	109	550	Ø570	368	485	190	140	110	280	685	35	1010	24	Ø75	20	M20x42	M63x1,5

Technische Daten / technical dates

Typ / type	YX3 280 S-4 IE2		Nennmoment / rated torque	(Nm)	481,8
Leistung / power	(kW)	75,0	Anlaufstrom-Nennstrom / starting current-rated current	(Ia/I _n)	6,5
Betriebsart / duty	S1		Anzugsmoment-Nennmoment / starting torque-rated torque	(M _a /M _n)	2,1
Nennzahl/ speed	(min ⁻¹)	1485	Kippmoment-Nennmoment / Pull-out torque	(M _k /M _n)	2,8
Nennstrom / rated current 400 V	(A)	128,4	Massenträgheitsmoment / moment of inertia	(kgm ²)	1,1648
Spannung / voltage (50 Hz)	(V)	380-420/660-720(e/Y)	Umgeb.-temp./ ambient temperature	40°C	
Frequenz / frequency	(Hz)	50	Lager / bearing	(DE)	6316
Wirkungsgrad / efficiency	(%)	94,2		(NDE)	6316
Leistungsfaktor / power factor	(cos φ)	0,90	Schutzart / protection	IP55	
Isolationsklasse / insulation class	F		Schallpegel / noise level	(dB (A))	81
			Gewicht / weight	(kg)	591

Schaltplan / connection diagram

