

## YX3 250 M-2 IE2

### Abmessungen Drehstrom-Asynchronmotor / dimensions three phase asynchron motor IM B5 (mm)

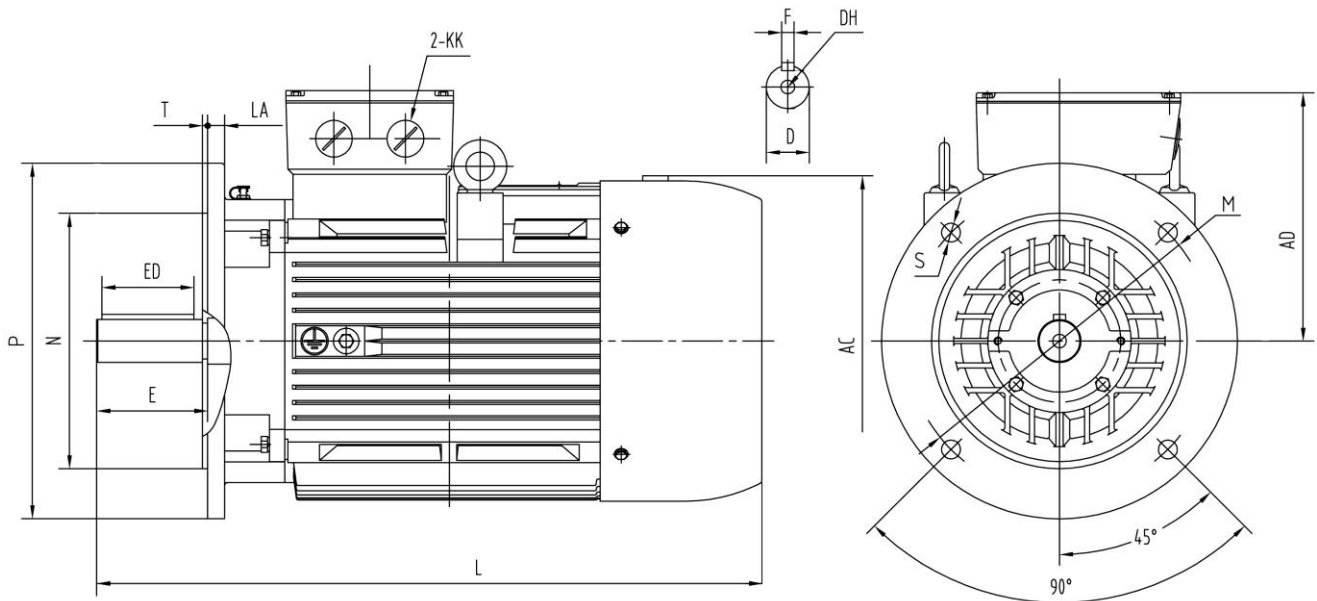

### Abmessungen / dimension

P	M	N	AC	AD	LA	T	E	ED	S	L	D	F	DH	KK
Ø550	Ø500	Ø450	Ø520	375	21	5	140	110	8xØ18,5	935	Ø60	18	M20x42	M63x1,5

### Technische Daten / technical dates

Typ / type	<b>YX3 250 M-2 IE2</b>		Nennmoment / rated torque	(Nm)	177,0
Leistung / power	(kW)	55,0	Anlaufstrom-Nennstrom / starting current-rated current	(I <sub>a</sub> /I <sub>n</sub> )	6,1
Betriebsart / duty	S1		Anzugsmoment-Nennmoment starting torque-rated torque	(M <sub>a</sub> /M <sub>n</sub> )	1,8
Nennzahl/ speed	(min <sup>-1</sup> )	2940	Kippmoment-Nennmoment Pull-out torque	(M <sub>k</sub> /M <sub>n</sub> )	2,9
Nennstrom / rated current 400 V	(A)	91,8	Massenträgheitsmoment / moment of inertia	(kgm <sup>2</sup> )	0,3214
Spannung / voltage (50 Hz)	(V)	380-420/660-720(Δ/Y)	Umgeb.-temp./ ambient temperature	40°C	
Frequenz / frequency	(Hz)	50	Lager / bearing	(DE)	6314
Wirkungsgrad / efficiency	(%)	93,5		(NDE)	6314
Leistungsfaktor / power factor	(cos φ)	0,92	Schallpegel / noise level	(dB (A))	90
Schutzart / protection	IP55		Gewicht / weight	(kg)	417
Isolationsklasse / insulation class	F				

### Schaltplan / connection diagram

