

YX3 250 M-6 IE2

Abmessungen Drehstrom-Asynchronmotor / dimensions three phase asynchron motor IM B3 (mm)

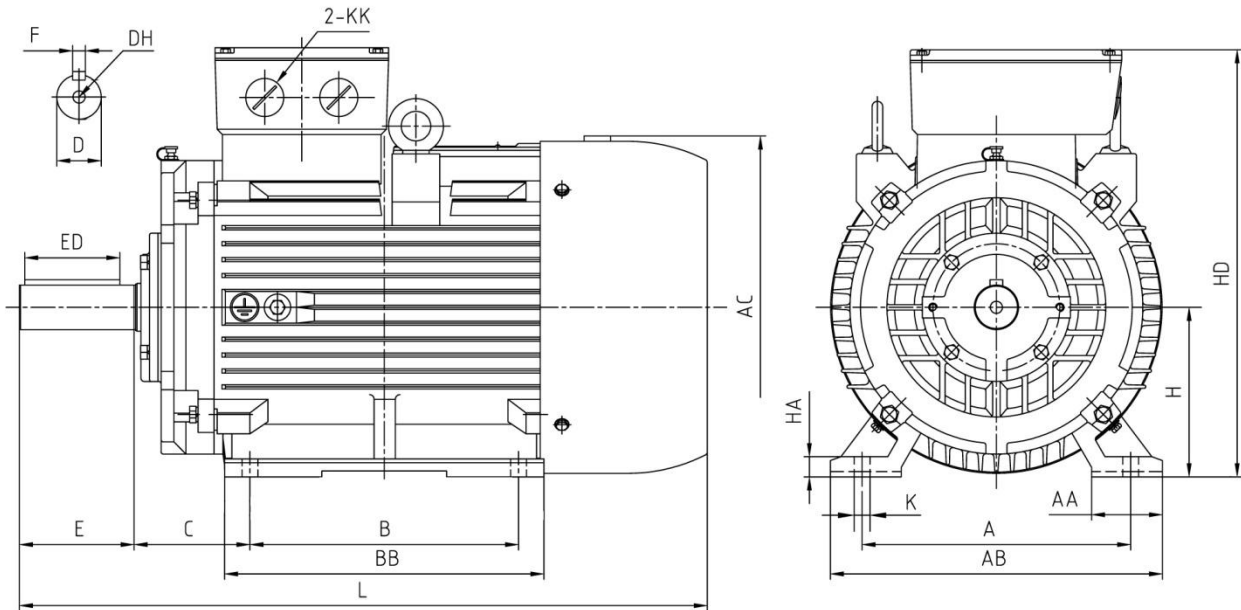

Abmessungen / dimension

A	AA	AB	AC	B	BB	C	E	ED	H	HD	HA	L	K	D	F	DH	KK
406	88	495	Ø520	349	440	168	140	110	250	625	33	935	24	Ø65	18	M20x42	M63x1,5

Technische Daten / technical dates

Typ / type	YX3 250 M-6 IE2		Nennmoment / rated torque	(Nm)	358,6
Leistung / power	(kW)	37,0	Anlaufstrom-Nennstrom / starting current-rated current	(I _a /I _n)	6,4
Betriebsart / duty	S1		Anzugsmoment-Nennmoment / starting torque-rated torque	(M _a /M _n)	2,2
Nennzahl/ speed	(min ⁻¹)	985	Kippmoment-Nennmoment / Pull-out torque	(M _k /M _n)	2,7
Nennstrom / rated current 400 V	(A)	65,6	Massenträgheitsmoment / moment of inertia	(kgm ²)	0,8757
Spannung / voltage (50 Hz)	(V)	380-420/660-720(Δ/Y)	Umgeb.-temp./ ambient temperature	40°C	
Frequenz / frequency	(Hz)	50	Lager / bearing	(DE)	6314
Wirkungsgrad / efficiency	(%)	92,7		(NDE)	6314
Leistungsfaktor / power factor	(cos φ)	0,88	Schutzart / protection	IP55	
Isolationsklasse / insulation class	F		Schallpegel / noise level	(dB (A))	75
			Gewicht / weight	(kg)	387

Schaltplan / connection diagram

