

YX3 200 L2-6 IE2

Abmessungen Drehstrom-Asynchronmotor / dimensions three phase asynchron motor IM B35 (mm)

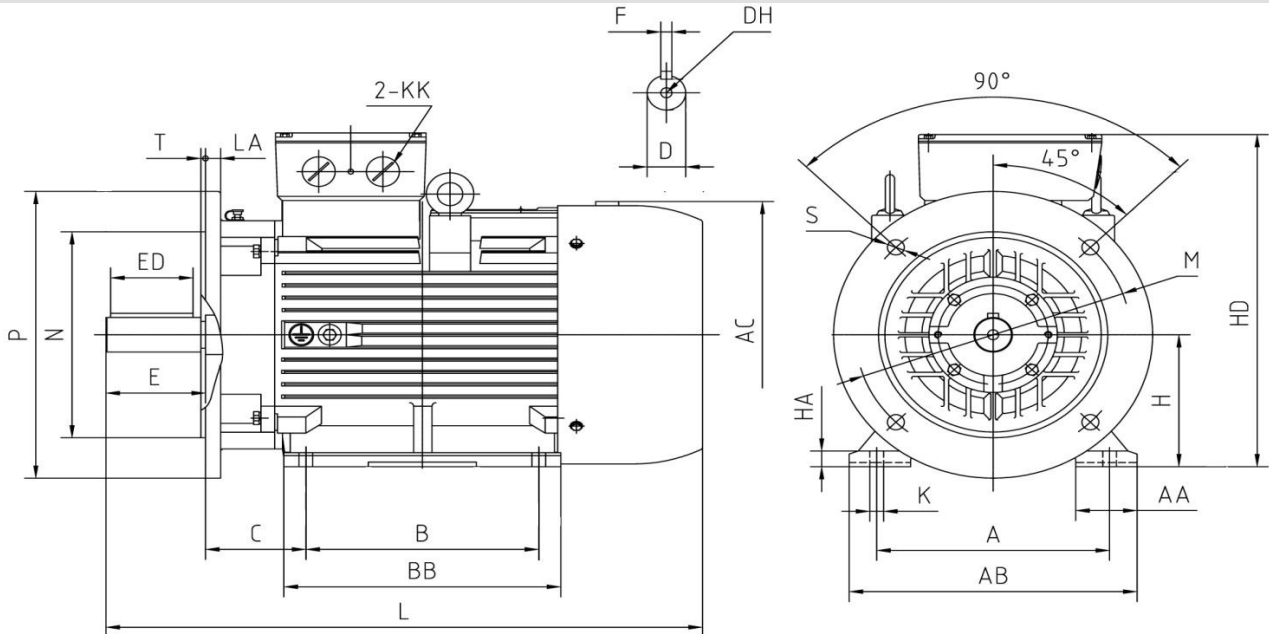

Abmessungen / dimension

A	AA	AB	AC	B	BB	C	E	ED	H	HD	HA	L	K	D	DH	KK
318	85	395	Ø420	305	370	133	110	90	200	524	25	770	18,5	Ø55	M20x42	M50x1,5
P	M	N	T	LA	S	F										
Ø400	Ø350	Ø300	5	17	4xØ18,5	16										

Technische Daten / technical dates

Typ / type	YX3 200 L2-6 IE2		Nennmoment / rated torque	(Nm)	214,1
Leistung / power	(kW)	22,0	Anlaufstrom-Nennstrom / starting current-rated current	(I _a /I _n)	5,9
Betriebsart / duty	S1		Anzugsmoment-Nennmoment / starting torque-rated torque	(M _a /M _n)	2,0
Nennzahl/ speed	(min ⁻¹)	980	Kippmoment-Nennmoment / Pull-out torque	(M _k /M _n)	2,6
Nennstrom / rated current 400 V	(A)	41,0	Massenträgheitsmoment / moment of inertia	(kgm ²)	0,3780
Spannung / voltage (50 Hz)	(V)	380-420/660-720(Δ/Y)	Umgeb.-temp./ ambient temperature	40°C	
Frequenz / frequency	(Hz)	50	Lager / bearing	(DE)	6312
Wirkungsgrad / efficiency	(%)	91,0		(NDE)	6312
Leistungsfaktor / power factor	(cos φ)	0,85	Schutzart / protection	IP55	
Isolationsklasse / insulation class	F		Schallpegel / noise level	(dB (A))	71
			Gewicht / weight	(kg)	240

Schaltplan / connection diagram

