

YX3 315 L1-2 IE2

Abmessungen Drehstrom-Asynchronmotor / dimensions three phase asynchron motor IM B35 (mm)

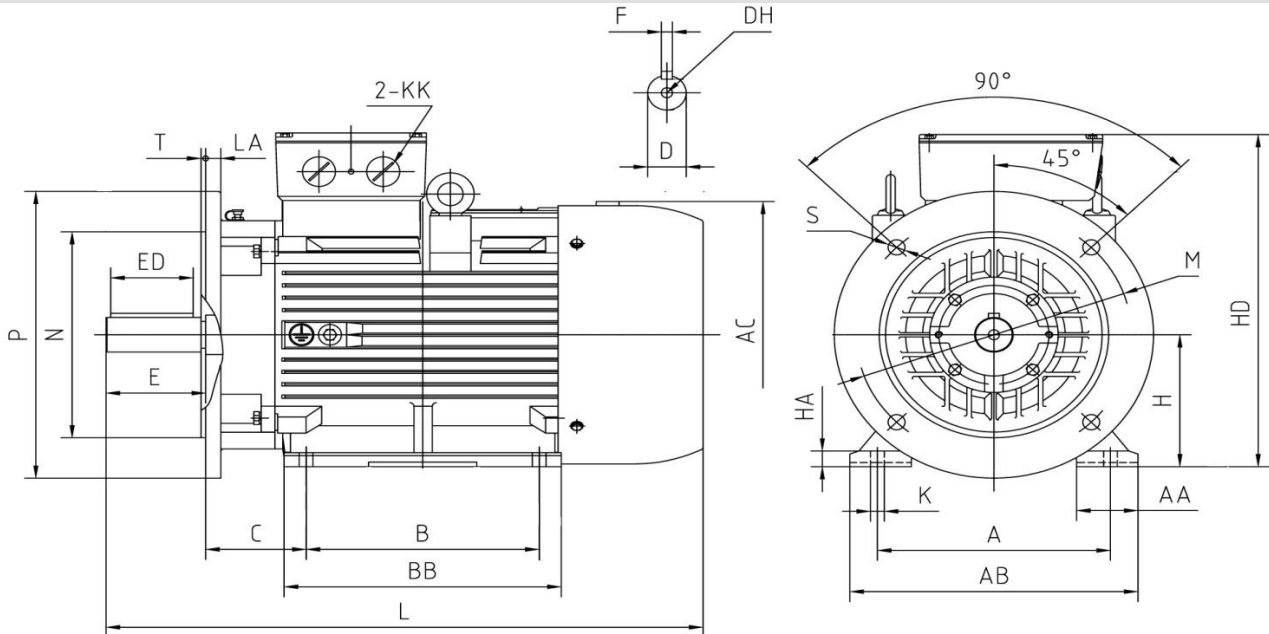

Abmessungen / dimension

A	AA	AB	AC	B	BB	C	E	ED	H	HD	HA	L	K	D	DH	KK
508	120	635	Ø650	457	675	216	140	110	315	870	45	1290	28	Ø65	M20x42	M63x1,5
P	M	N	T	LA	S	F										
Ø660	Ø600	Ø550	6	24	8xØ24	18										

Technische Daten / technical dates

Typ / type	YX3 315 L1-2 IE2		Nennmoment / rated torque	(Nm)	513,8
Leistung / power	(kW)	160,0	Anlaufstrom-Nennstrom / starting current-rated current	(Ia/In)	7,3
Betriebsart / duty	S1		Anzugsmoment-Nennmoment / starting torque-rated torque	(Ma/Mn)	2,0
Nennzahl/ speed	(min ⁻¹)	2940	Kippmoment-Nennmoment / Pull-out torque	(Mk/Mn)	3,0
Nennstrom / rated current 400 V	(A)	261,7	Massenträgheitsmoment / moment of inertia	(kgm ²)	1,8128
Spannung / voltage (50 Hz)	(V)	380-420/660-720(Δ/Y)	Umgeb.-temp./ ambient temperature	40°C	
Frequenz / frequency	(Hz)	50	Lager / bearing	(DE)	6316
Wirkungsgrad / efficiency	(%)	95,5		(NDE)	6316
Leistungsfaktor / power factor	(cos φ)	0,92	Schutzart / protection	IP55	
Isolationsklasse / insulation class	F		Schallpegel / noise level	(dB (A))	87
			Gewicht / weight	(kg)	1151

Schaltplan / connection diagram

