

YX3 160 L-4 IE2

Abmessungen Drehstrom-Asynchronmotor / dimensions three phase asynchron motor IM B3 (mm)

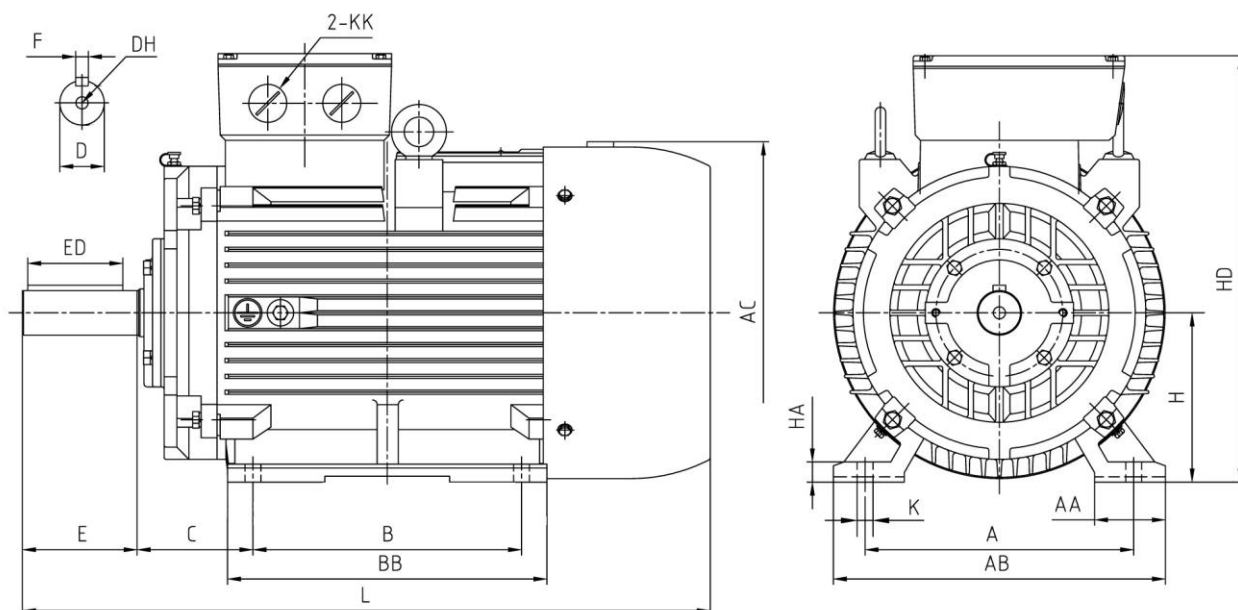

Abmessungen / dimension

A	AA	AB	AC	B	BB	C	E	ED	H	HD	HA	L	K	D	F	DH	KK
254	67	320	Ø330	254	305	108	110	90	160	410	19	655	14,5	Ø42	12	M16x36	M40x1,5

Technische Daten / technical dates

Typ / type	YX3 160 L-4 IE2		Nennmoment / rated torque	(Nm)	97,4
Leistung / power	(kW)	15,0	Anlaufstrom-Nennstrom / starting current-rated current	(I _a /I _n)	7,1
Betriebsart / duty	S1		Anzugsmoment-Nennmoment starting torque-rated torque	(M _a /M _n)	2,1
Nennzahl/ speed	(min ⁻¹)	1470	Kippmoment-Nennmoment Pull-out torque	(M _k /M _n)	2,6
Nennstrom / rated current 400 V	(A)	28,1	Massenträgheitsmoment / moment of inertia	(kgm ²)	0,0957
Spannung / voltage (50 Hz)	(V)	380-420/660-720(Δ/Y)	Umgeb.-temp./ ambient temperature	40°C	
Frequenz / frequency	(Hz)	50	Lager / bearing	(DE)	6309
Wirkungsgrad / efficiency	(%)	91,1		(NDE)	6309
Leistungsfaktor / power factor	(cos φ)	0,85	Schutzart / protection	IP55	
Isolationsklasse / insulation class	F		Schallpegel / noise level	(dB (A))	71
			Gewicht / weight	(kg)	169

Schaltplan / connection diagram

